

# MACT300L series

AIR UNITS (F.R.L.UNIT)

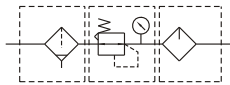

Symbol:



Order example:

MACT300L — 8A — □ — T8 — BSP

MODEL

BORE SIZE

8A: PT 1/4  
10A: PT 3/8

D: auto drain valve (FMRF300)

Module mounting bracket

T8: PT 1/4  
T10: PT 3/8

- Case is made of NYLON material, suitable for crucial environment.
- Longer case for adapting high efficient auto drain valve.

## Specification:

Model	MACT300L	
Components	MAF300L, MAR301, MAL300L	
Bore No.	8A	10A
Port size	PT 1/4	PT 3/8
Medium	Air	
Operating pressure range	0~9.9 kgf/cm <sup>2</sup> (0~0.99 MPa)	
Proof pressure	15 kgf/cm <sup>2</sup> (1.5 MPa)	
Effective orifice	32mm <sup>2</sup>	34mm <sup>2</sup>
Regulation pressure range	0.5~8.5 kgf/cm <sup>2</sup> (0.05~0.85 MPa)	
Ambient temperature	-5~+60°C (No freezing)	
Filtration	Standard: 5 μm Option: 40 μm	
Lubricating oil capacity	65c.c	
Min. flow for oil drip	50 l/min	60 l/min
Recommended lubricating oil	Turbine oil ISO-VG32	
Attachment	Pressure gauge, T-type bracket	
Weight	1000 g	

## Flow feature:

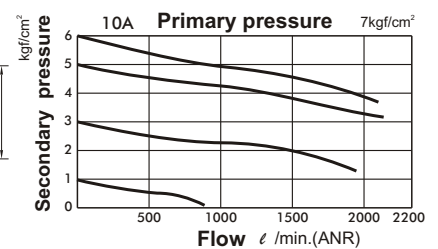
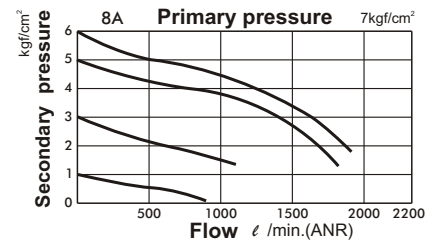

PORT THREAD  
Blank: PT thread  
BSP: BSP thread  
NPT: NPT thread

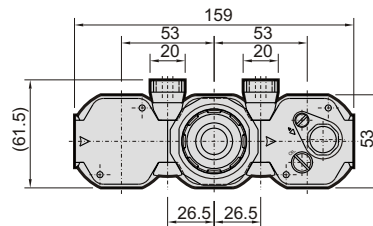
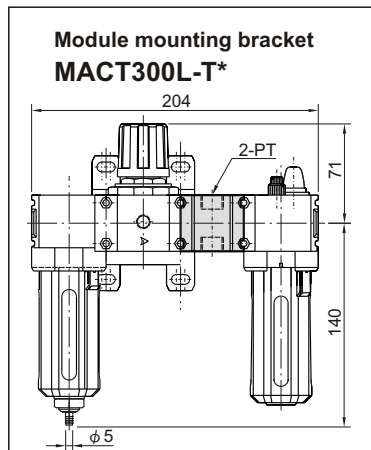

MACT300L-D

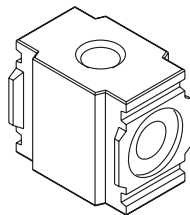
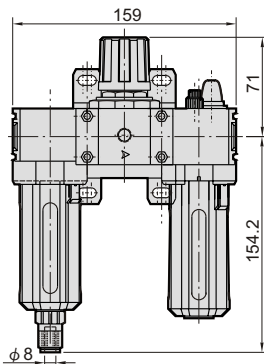

	PT
T8	PT 1/4
T10	PT 3/8

